

CONFIDENTIAL

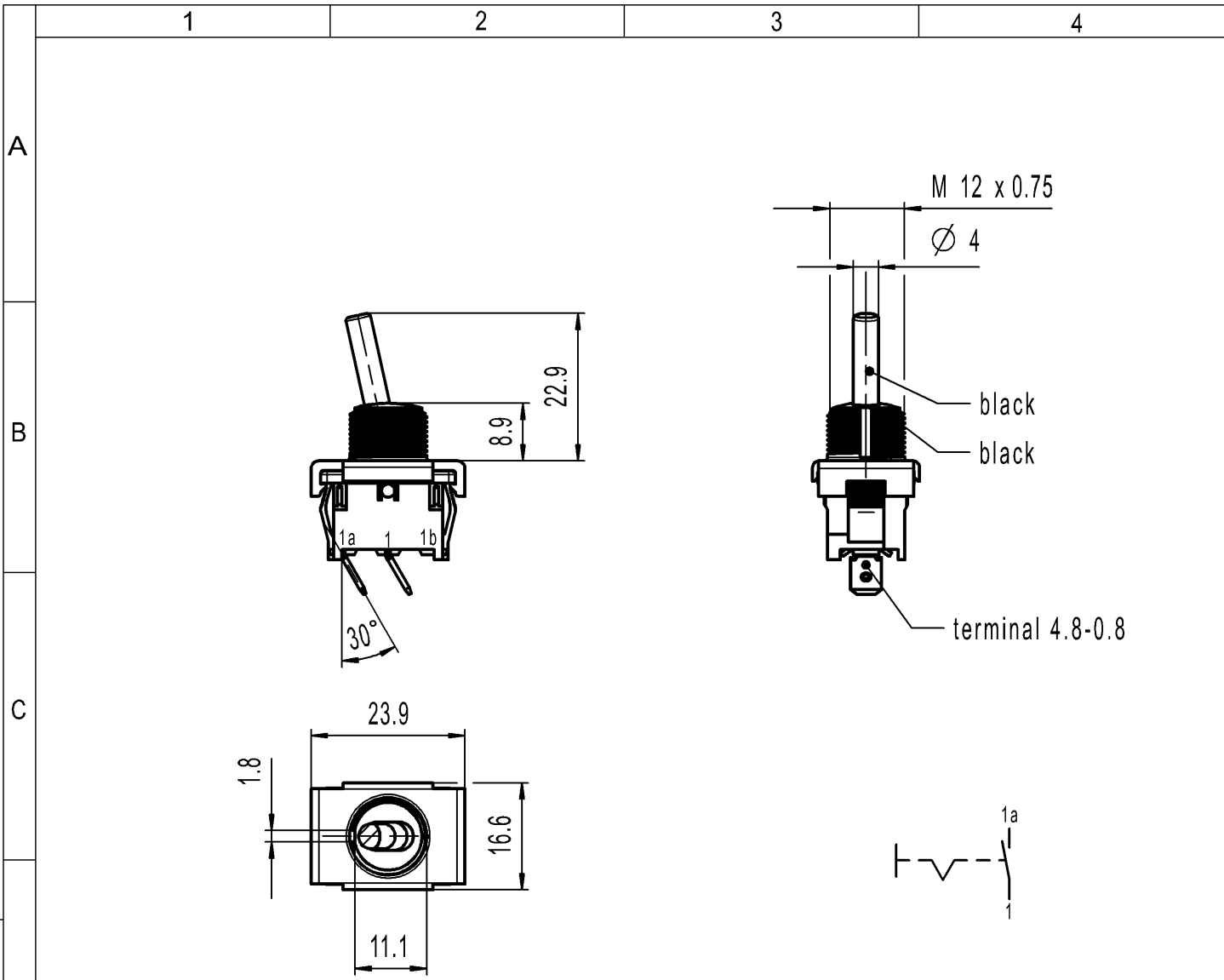



VERTRAULICH

Alle Rechte bei Marquardt, auch fuer den Fall von Schutzrechtsanmeldungen. Jede Veruegungsbefugnis, wie Kopier- und Weitergaberecht, bei uns.

THIS DRAWING IS THE EXCLUSIVE PROPERTY OF MARQUARDT. WITHOUT THEIR CONSENT IT MAY NOT BE REPRODUCED OR GIVEN TO THIRD PARTIES.





Marking

  
 1821.
   
 6(4)/250~5E4 T100/55
   

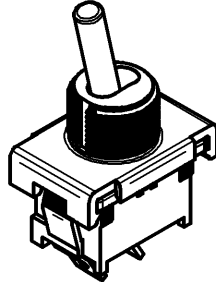
  
 6A 125-250V AC
   
 1/4 HP 125V AC
   
 1/2 HP 250V AC
   
 R30  
  
 Code of manufacture: place/year/week

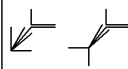
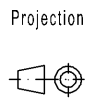
SPST  
Suitable for appliances of class II



-	-	-	1821.1401-XX					
Figure	Type	Customer No.	Art.No.-PI					
General tolerances		Sheet 01	Ident. K					
All dimensions are in millimetres	Shape and location 	Angle $\pm 2^\circ$	Edge tolerance 	Length	Radii	Document number 18211401	Index e	
				0-6	$\pm 0.2$			$\pm$
				>6-15	$\pm 0.4$			$\pm$
				>15-30	$\pm 0.4$			$\pm$
				>30-70	$\pm$			$\pm$
				>70-120	$\pm$			$\pm$
>120	$\pm$	$\pm$						
e	131663	2020-09-08	PANDHAREA	Format DIN A4	Projection 	Scale 1:1	Appliance Switch	
d	64505	2010-01-27	MUT	System NX V11.0	 <b>MARQUARDT</b>			
c	43241	2005-06-17	mut	Replacement of Zg.gl.Nr.v.15.11.2000				
b	29868	2000-06-19	BMI					
Index	MEC-No.	Date (YYYY-MM-DD)	Edited by					